



TASSEL™ 57

PENDANT

THE TASSEL SERIES CONDENSES THE WARMTH AND DECADENCE OF A TRADITIONAL CHANDELIER TO A CONCISE, MODERN CONCLUSION. EMANATING FROM A BRASS DOME, THE LIGHT IS AMPLIFIED AS IT REFRACTS THROUGH MOLD-BLOWN GLASS CYLINDERS.

© 2016, APPARATUS LLC
WWW.APPARATUSSTUDIO.COM/PATENTS

A P P A R A T U S

INFO@APPARATUSSTUDIO.COM / 646.527.9732

A P P A R A T U S S T U D I O . C O M

TASSEL™ 57

PENDANT

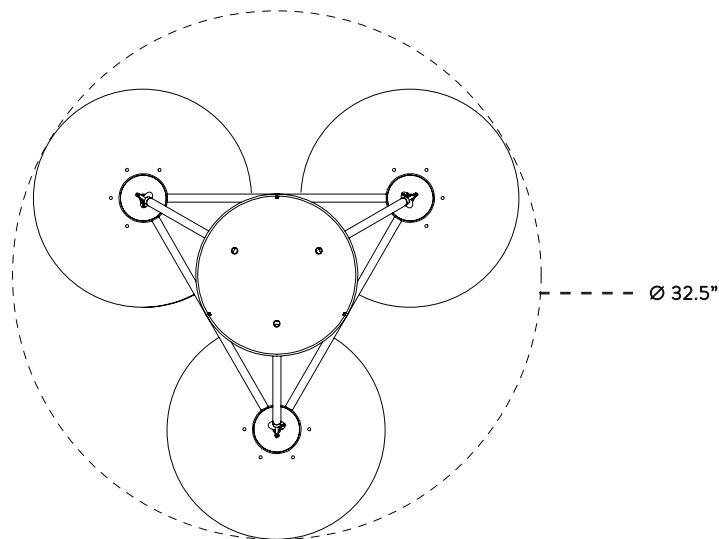
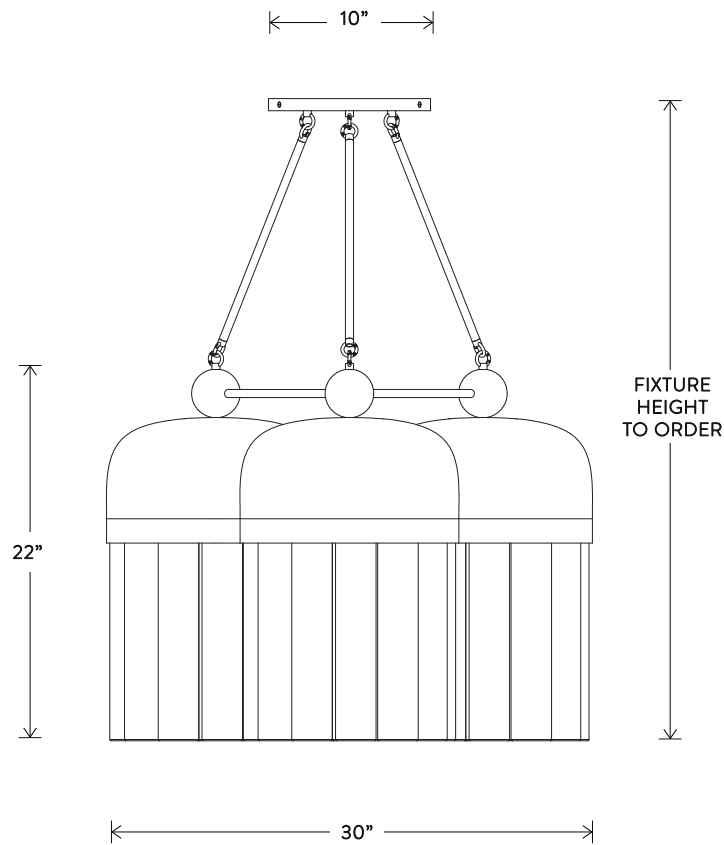

DIMENSIONS: Ø 32.5"
WEIGHT: APPROX. 300 LBS
HEIGHT TO ORDER
MINIMUM HEIGHT 40"
INCLUDES UP TO 85"
ADDITIONAL HEIGHT \$30 PER INCH
APPROXIMATE WEIGHT: 200 LBS

LAMPING: 3 18W DIMMABLE LED MODULES
1750 LUMENS EACH, 2700K COLOR TEMPERATURE
LED ONBOARD DRIVER
BULB LIFE: 50,000 HOURS

UL / CE APPROVED
VOLTAGE: 120-240

FINISHED AND ASSEMBLED BY HAND IN NY FROM
DOMESTIC AND IMPORTED COMPONENTS.
CUSTOMIZATION AVAILABLE.
ALL PIECES MADE TO ORDER.
50% DEPOSIT REQUIRED.
BALANCE DUE PRIOR TO SHIPPING.
LEAD TIME APPROXIMATELY 8-10 WEEKS.

\$34400
FINISHES TO ORDER
ADD 30% FOR TARNISHED SILVER

REQUIRES A MAGNETIC LOW VOLTAGE DIMMER

© 2016, APPARATUS LLC
WWW.APPARATUSSTUDIO.COM/PATENTS

A P P A R A T U S

INFO@APPARATUSSTUDIO.COM / 646.527.9732

A P P A R A T U S S T U D I O . C O M